



# NEX

GENERATION  
FLYING SAILS FURLER

# NEX

## Flying sail furlers

### NEX, THE NEW GENERATION FURLER

The new version of the Nex furler is now available with many innovations and technological improvements. These innovations, resulting from our expertise gained since the launch of the first version of the NEX in 2010 will bring you even more performance, safety and comfort when sailing.

Its range of 7 models covers all sizes of sails (up to 350m<sup>2</sup>) and enables it to equip boats of more than 80'.

#### Why choose a NEX furler?

- **Performance:** Speed of furling, weight and optimized footprint
- **Comfort and safety** during furling/unfurling operations FurlAssist (pawl function ), ease of furling
- **Ease of use:** easy installation, fast and intuitive sail trimming
- **Reliable,** proven and maintenance-free technology
- **Wide range of end fittings** for better adaptation to your deck layout
- **Product with modern design**
- **3-year international warranty**



## What types of sails?

NEX furlers are intended for flying light wind or heavy sails. Developed in partnership with the largest sailmakers, the NEX furlers allow you to get the best out of your sails while handling them easily and safely

↘ **Light sails:**  
Gennaker, Code 0, Screacher, light genoa

↘ **Heavy sails:**  
• Solent, stay sail

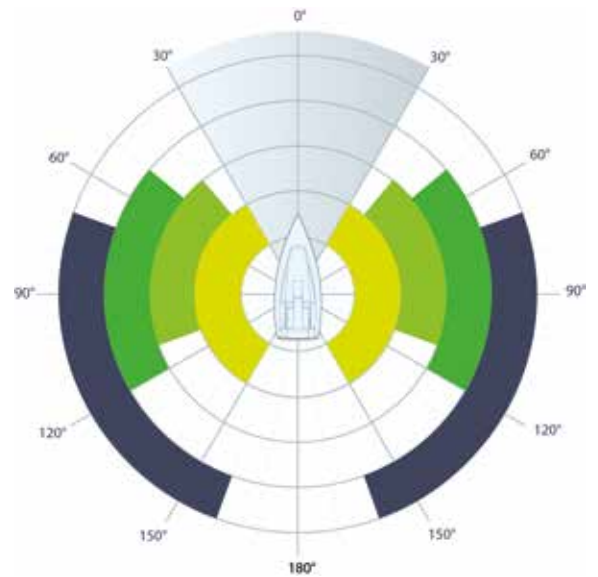
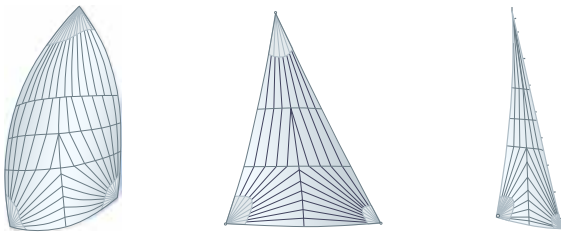

## NEX furlers: the reference in the racing world:

Since their launch in 2010, NEX furlers have often been in the lead in offshore races and have been chosen to equip the most efficient yachts:

- IMOCA,
- Class 40,
- Ultim,
- Multi 50,
- M32,
- Mini 6.50
- Etc...



# NEX

## Flying sail furlers

### SAFETY

#### SAFE SYSTEM : Removable line

Already present on the 1st generation of NEX, the SAFE SYSTEM enables you to stop the furling line running during sail deployment and therefore helps:

- prevent accidents or damage caused by a free running line.
- manoeuvre more quickly and easily
- prevent excessive wear of the line



#### NEW TERMINALS:

- Swivel eye
- Compact halyard block
- Solid sheave

See pages 30 and 31

### PERFORMANCE

#### OPTIMUM FURLING : Furl quickly and without effort

A real technological improvement, Nex drums are the widest on the market and provide:

- Fast furling speed
- Comfortable furling needing less effort during manoeuvres. A real advantage with small crews



#### XTRA-LITE SYSTEMS : Continuously striving for lightness

The general design and the choice of materials enable us to offer systems that are ever lighter for:

- Improved performance of the boat
- Ease of use of the systems during manoeuvres



#### S-GRIP : Better line grip

The specific design of the drum groove provides:

- Better rope grip
- Easier sail furling without skidding
- Limited rope wear



**NEW :**  
Anti-shock housing for  
better protection and longer life



## EASY TO USE

### **I-CONNECT :** **Quick fit sailing system**

Available on swivel shackle and drum mechanisms, I-Connect offers:

- Quick opening and closing of the pin by pulling on the ball (regardless of the direction of the force)
- Excellent grip (even with gloves)
- A simple new mechanism without jamming - easy to dismantle



### **QUICK FIT :** **Line Fitting**

Already present on the 1st NEX, Quick Fit makes fitting and removing a spliced line quick and easy:

- Quick Installation
- Possibility of splicing to length
- Possibility of leaving the line in position
- Possibility of using the same line for several systems



### **TUNE & LOCK :** **Easy fitting and adjustment**

Installation and adjustment of the housing is made simple with a single screw:

- Precise adjustment of the housing according to the orientation of the line
- Decreases the friction of the line on the housing
- Automatic height adjustment of the housing



## INNOVATION!

### **FURLASSIST:** **INTUITIVE AND SAFE ASSISTANCE** **FOR FURLING**

**A MAJOR INNOVATION** of this new Nex range, the FURLASSIST ratchet function is a real plus for your manoeuvres allowing::

- Better control of furling avoiding accidental unfurling of the sail
- Reliable furling due to the permanent engagement of the pawl
- Safety: it only unlocks when hauling in the line fast
- Simplicity: operates in both directions and without additional line
- Easy installation and removal (2 screws)

# NEX

## Flying sail furlers

### SELECTION TABLE

	NEX 0.9	NEX 1.5	NEX 2.5	NEX 4.0	NEX 6.5	NEX 8.0	NEX 12.0
<b>Light sail area (i.e gennaker)*</b>	35m <sup>2</sup>	60 m <sup>2</sup>	80 m <sup>2</sup>	120 m <sup>2</sup>	220 m <sup>2</sup>	250 m <sup>2</sup>	350 m <sup>2</sup>
<b>Stormsail area*</b>		20 m <sup>2</sup>	30 m <sup>2</sup>	45 m <sup>2</sup>	65 m <sup>2</sup>		
<b>Option : Ratchet feature FurlAssist</b>	-	√	√	√	√	√	√
<b>Working Load**</b>	900 Kg	1500 Kg	2500 Kg	4000 Kg	6500 Kg	8000 Kg	12.000 Kg
<b>Spool diameter</b>	120 mm	150 mm	180 mm	220 mm	220 mm	250 mm	250 mm
<b>Standard lower terminal</b>	Clevis pin snap shackle	Clevis pin snap shackle	Clevis pin snap shackle	Clevis pin snap shackle	Trigger snap shackle	Trigger snap shackle	
<b>Standard upper terminal</b>	Swivel eye	D shackle	D shackle	D shackle	D shackle	D shackle	D shackle
<b>Examples for a monohull</b>	Mini 6.50 - Cruising boat 27'	Cruising boat 32'	Cruising boat 42'	Cruising boat 50'	Cruising boat 55'	Cruising boat 60'	Cruising boat +65'

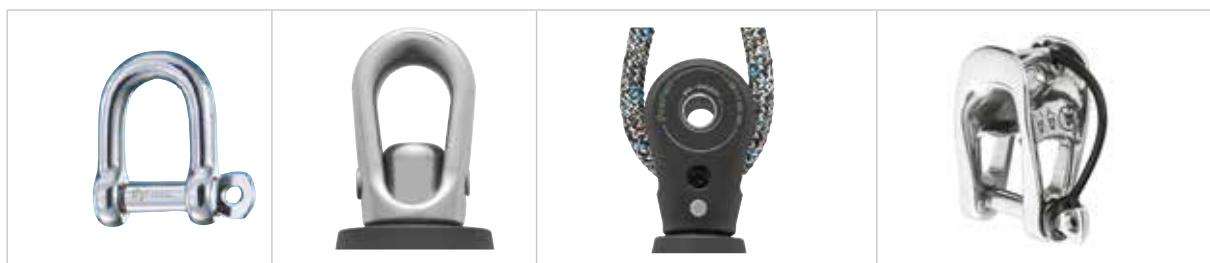

Description	D shackle	Eye	Halyard block	MXEvo: halyard shackle
<b>For models</b>	As standard on all models but NEX 0.9	<ul style="list-style-type: none"> <li>• NEX 0.9: as standard</li> <li>• Option: from NEX 1.5 to NEX 6.5</li> </ul>	<ul style="list-style-type: none"> <li>• Option for all models (not available for NEX 0.9 &amp; NEX 1.5)</li> </ul>	<ul style="list-style-type: none"> <li>• Option for all models</li> </ul>
<b>Benefits</b>	<ul style="list-style-type: none"> <li>• Wichard forged shackle in High resistance stainless steel</li> </ul>	<ul style="list-style-type: none"> <li>• Compact</li> <li>• Prevents the rope wear</li> <li>• Perfect for lashings</li> </ul>	<ul style="list-style-type: none"> <li>• 2/1 halyard</li> <li>• No loop - no twist</li> <li>• Compact</li> <li>• Dismantable</li> <li>• With balls + bearing</li> </ul>	<ul style="list-style-type: none"> <li>• 2/1 halyard</li> <li>• Becket for 3/1 purchase</li> <li>• Heavy load</li> <li>• Compact</li> <li>• Stainless steel</li> <li>• Rope dia: 8 to 14 mm</li> </ul>
<b>Upper terminals</b>	√	√	√	√
<b>Lower terminals</b>	X	√	√	√

\*: The values shown in the table are for information only and should be verified by a professional taking into account the characteristics of the boat.

\*\* The working loads shown are the maximum working loads of the mechanisms only and are not the loads of the complete system when terminals are included. The product should not be used above these working loads in any circumstances.

## Profurl + points: Proven and unique technology

- Performance even under high loads
- Reliability and longevity of the mechanisms



NEX furlers and manual furlers share the Profurl technology that has created the reputation of the brand: Profurl mechanisms are the only ones to use bearings made from very hard **100C6 carbon steel** which allow furling even under high loads (no crushing of the balls). The mechanism is mounted in a waterproof grease bath and is protected from external aggressions (salt, sand, etc.) and does not require any maintenance.



**Clevis pin snap shackle**

- As standard on all models from NEX 0.9 to NEX4.0

- Wichard forged snap shackle
- Ergonomic ball for quick opening

X

✓



**Speedlink: trigger snap shackle**

- As standard from NEX 6.5 to 8.0

- Wichard forged snap shackle
- Quick opening
- Compact

X

✓



**Solid sheave**

- Option: from NEX1.5 to NEX12.0

- With becket
- Quick opening
- 3/1 purchase
- Stainless steel

X

✓



**Swivel hook**

- NEX4.0, NEX 6.5 and NEX8.0

- Weight savings
- Compact
- Ease of installation (no drilling)
- Reduce mast compression

✓

X

# NEX

## Flying sail furlers

### ACCESSORIES

#### SWIVEL TACK POINT FOR SPINNAKER :

Spinnaker tack: available for Nex 4.0, 6.5 and 8.0, spinnaker tacks connect to the drum and allow you to furl asymmetric spinnakers top down.



#### STAINLESS STEEL AND ALUMINIUM THIMBLES

Available in stainless steel or aluminium, their form facilitates the positioning of the sail in the mechanism forks. Their cut-outs allow good positioning of the lashings avoiding excessive wear. Stainless steel thimbles are an economical solution. Aluminium thimbles provide performance and lightness; they are used for racing programmes.



#### CABLE-FREE THIMBLES

The cable-free thimbles aim at being installed on sails without furling cable. Their specific design enables the optimized furling and easy fitting of the webbings..

Available in 3 sizes for NEX2.5, 4.0, 6.5 and 8.0



#### ANTI-TORSION CABLE CLAMPS

For anti-torque cables (dia 9, 11, 13 and 15 mm)

- Can be used for gennaker with Marlow ProDrive +
- Can be used for asymmetric spinnakers with most of the anti-torque cables available on the market
- Material : Duplex grade stainless steel



#### ANTI-TORQUE CABLES :

Profurl offer anti-torque cables cut at length in various diameter

- Dynex Hampidjan cable - available in 9, 11, 13 and 15 diameter
- Cable Marlow ProDrive2 - available in 9, 11, 13 and 15 diameter



#### SPLICED FURLING LINES

Available in 8 and 10 mm diameter - From 12 to 26m

High quality spliced furling line offering higher product lifetime. Prevents the risk to be locked into the spool.





## FLYING SAIL FURLER WITH DRUM

- > With a drum and a single furling line similar to manual headsail furler.
- > Economical system.
- > Easy to install on board



Non contractual photo

**Contact us for more information**

## TECHNICAL DATA

Technical data: spool	NEX 0.9	NEX 1.5	NEX 2.5	NEX 4.0	NEX 6.5	NEX 8.0	NEX 12.0
Height pin to pin: A mm	74,1	80,8	99,7	115	126	133	134
Width drum mechanism: B mm	128	160	192	232	232	262	262
Width fork: C mm	12	15	18	19	25,1	25,1	26
Depth under pin: F mm	18	22	26	33	39	39	40
Ø pin G mm	8	8	10	12	14	14	18
Ø spool: mm	120	150	180	220	220	250	250
Ø continuous line mm	Ø8	Ø8	Ø8-Ø10	Ø10	Ø10	Ø10	Ø10-Ø12
Weight: spool (only) Kg	0,380	0,540	0,995	1,490	1,730	2,440	NC
Technical data: swivel							
Height pin to pin: D mm	63,3	56,2	68,3	82,7	97,7	104,5	115
Width swivel: E mm	31	34	42	50	60	65	70
Width fork: C mm	12	15	18	19	25,1	25,1	26
Depth under pin: F mm	18	22	26	33	39	39	40
Ø pin G mm	8	8	10	12	14	14	18
Weight: swivel (only) Kg	0,110*	0,140	0,260	0,470	0,730	0,970	NC
Max Ø luff line mm	9	11	13	15	17	19	21

\*: included eye terminal

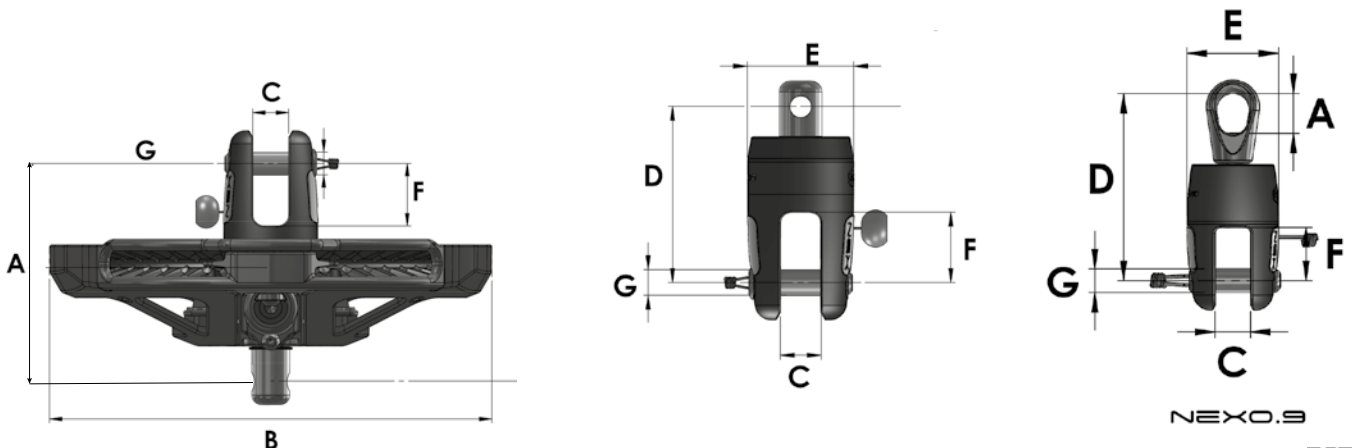

# NEX

## Flying sail furlers

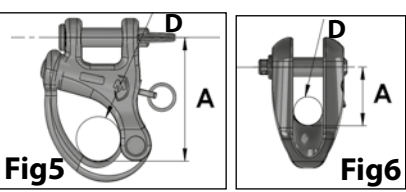
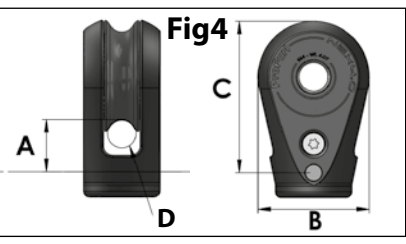
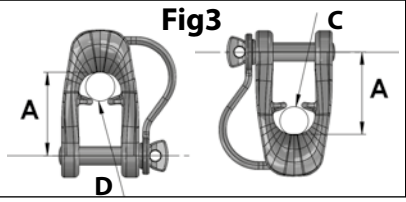
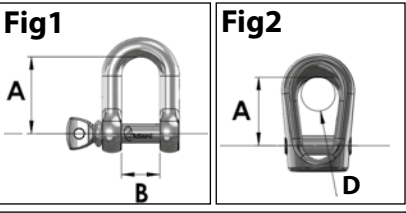

	NEX 0.9	NEX 1.5	NEX 2.5	NEX 4.0	NEX 6.5	NEX 8.0	NEX 12.0
Wichard HR shackle: Fig 1		Part # 11203	Part # 11204	Part # 11205	Part # 11206	Part # 11207	Part # 11208
ø pin (mm)	-	6	8	10	12	14	16
A / B (mm)	-	24/12	32/16	40 / 20	48/24	56/28	64/32
Weight Kg	-	0,024	0,052	0,102	0,192	0,304	0,464
Eye: Fig 2							
A (mm)	13,5	22,5	27,5	35,5	45,8	51,7	NC
D Inner ø. max (mm)	11	13	17	22	28	32	NC
Weight (Kg)	0,018	0,034	0,078	0,142	0,287	0,429	NC
MXEvo : halyard shackle Fig 3		MXEvo 6	MXEvo 8	MXEvo 10			
A (mm)	-	32	35	43,5	-	-	-
D:ø int. max (mm)	-	9	11	15	-	-	-
Poids (kg)	-	0,053	0,109	0,222	-	-	-
Halyard block: Fig 4							
A (mm)	-	-	21,5	17,9	31,5	42,5	NC
Sheave ø : B (mm)	-	-	45	58	64	80	NC
Height : C (mm)	-	-	63	79	90	115	NC
D: Max Inner ø (mm)	-	-	10	12	14	16	NC
Weight Kg	-	-	0,175	0,300	0,490	0,945	NC
Snap shackle: Fig 5	Part # 54100	Part # 54100	Part # 54101	Part # 54102			
: A (mm)	39,6	39,6	54	65	NC	NC	-
D: Max inner ø (mm)	16	16	21	26	NC	NC	-
Weight (Kg)	0,054	0,054	0,130	0,257	NC	NC	-
Solidsheave 3:1: Fig 6							
A (mm)	-	26,8	29	31	30,5	45,85	NC
D: Max inner ø (mm)	-	10	12	16	18	23	NC
Weight Kg	-	0,113	0,200	0,280	0,350	0,750	NC

### Stainless steel thimbles: Fig 7

	NEX 0.9	NEX 1.5	NEX 2.5	NEX 4.0	NEX 6.5	NEX 8.0	NEX 12.0
Part #	59164	59025	59026	59027	59028		NA
A (mm)	40	57	67,5	78	105		NA
B (mm)	11,5	14,5	17,5	18,5	24,8		NA
C (mm)	30	38	45	52	70		NA
ø d (mm)	8,3	8,3	10,3	12,3	14,3		NA
E (mm)	12	16	18,5	21,5	30		NA
ø F (mm)	9	11	13	15	20		NA
Weight Kg	0,030	0,073	0,126	0,190	0,382		NA

### Aluminium thimbles: Fig 8

	NEX0.9	NEX 1.5	NEX 2.5	NEX4.0	NEX 6.5	NEX 8.0	NEX12.0
Part		59165	59166	59167	59168		NA
A (mm)	-	56	66,5	79	108		NA
B (mm)	-	14,5	17,5	18,5	24,8		NA
C (mm)	-	38	45	54	70		NA
ø d (mm)	-	8,3	10,3	12,3	14,3		NA
E (mm)	-	15	17,5	21	31,5		NA
ø F (mm)	-	11	13	15	19		NA
Weight Kg	-	0,032	0,054	0,074	0,190		NA

### Cableless thimbles: Fig 9

		NEX 2.5	NEX 4.0	NEX 6.5	NEX 8.0
Top thimble	Part #				
	A mm	45.50	63.50	81	
	B mm	22*7	27*7	47*12	
	C mm	10	12	14	
	Weight Kg	0.100	0.163	0.349	
Bottom thimble	Part #				
	A mm	50.3	68.25	89.70	
	B mm	22*7	27*7	47*12	
	C mm	10	12	14	
	Weight Kg	0.107	0.177	0.484	

